

LAPAROSCOPY INSTRUMENTS



*GerMed*USA™

Address: 2417 Jericho Turnpike, #333, Garden City Park, NY 11040 (USA).
Phone: +1(516) 997-2180 Fax: +1(516) 358 2182 Email: sales@germedusa.com

About the Company	2
Deep Suture	3-4
Spekulum for Gallbladder Extraction	5
Trocarsleeves, Trocars	6-8
Reducer sleeves, Dilation Set, LAP-Accessories	9
Autoclavable Laparoscopes	10
Fiber Light Cables	11
Hook-tip Electrodes	12-15
Suction and Irrigation Tubes	16-17
Accessories for Laparoscopy / Cholecystectomy	18
Rotating and Detachable Instruments	19-35
Endo-Hook-System	36-38
Clip-Applier and Knot slider	39
Care and Cleaning	40
Handles	41-42
Detachable Forceps (Bipolar)	43-44
Graspers with Spring-Handle	45

Special models available upon request

ABOUT US

GerMedUSA Inc. is the leading manufacturer of high-quality surgical instruments worldwide. At most economical prices, we offer premium quality surgical instruments, immediately available for delivery anywhere in the world. Our broad range of surgical instruments undergoes a series of quality control testing to get excellent products. We offer a wide selection of Surgical Instruments, including; Dental Instruments, Orthopedic Surgical Instruments, Operating Room Surgical Instruments, Podiatry Surgical Instruments, Rainbow Surgical Instruments, Left Hand Instruments, Thoracoscopy, Gynecological Instruments, Dermal Instruments, Ear Instruments, Eye Instruments, Hemostatic Forceps, Cardiovascular Thoracic Instruments, Floor Grade Economy Instruments, and Tungsten Carbide Insert Needle Holders and Scissors.

GerMedUSA Inc. journey that began three decades ago has successfully become a symbol of Excellence, Innovation, and Reliability for veterinarians worldwide. Strictly following the **FDA** guidelines and being **ISO 13485 certified**, all our procedures are documented, and every process is being monitored at every level. We have acquired an unmatched and unique understanding of manufacturing. Our state-of-the-art manufacturing facilities and years of experience have helped us keep prices low and provide quality products. We believe more in building a strong relationship than just selling the instruments. Therefore, we enjoy providing superior customer services from the first query to the last and offer free sharpening on all our Scissors for the life of the instrument & all Dental Elevators/Luxating Elevators.

Yet, **GerMedUSA Inc.** believes that there is no end when it comes to success and perfection. Therefore, we continuously work with top-notch professionals to understand the changing market needs and future trends to develop the instruments that make them fall in love with their job. Our team of Expert Consultants is available for you whenever you need them. Order a free CD-Rom "Our electronic catalog" to save your time and deliver your order without any hassle.

Want to talk to us? Start a live chat or reach out to us via social media platforms. Or if you are looking for an instrument that we do not have, please get in touch, we will manufacture it for you.

We would love your honest feedback about what we are doing great and what improvements we need. Thanks in advance for your time and input.

Guarantee

All our surgical instruments are guaranteed to be free from any defects in material and workmanship. Any material or instrument found to be defective will either be replaced or repaired based on the evaluation. This service is free of any cost. Our responsibility under guarantee shall be limited to only replacement and repaired policy of defective merchandise.

The good results of open abdominal surgery can hardly be improved upon using conventional techniques. Through the application of modern video-endoscopic technology and appropriate instruments, however, the trauma of operative access can be substantially reduced. Small punctures replace abdominal sections. The advantages of minimal invasive surgery are the results.

With a number of newly developed instruments Germed USA would like to make an up-to-date contribution to laparoscopic operating techniques.

The deep peritoneum and fascia closure of an endoscopic access involves technical problems, but is desirable in order to avoid any complications (hernia, concrescence).

With Germed USA Deep Suture, we offer you a simple, quick and sure solution. This instrument is a rod-shaped sewing device with a diameter of 12 mm which can be inserted through the endoscopic working channels without any problem. The wound channel lies tightly against the outer guide rod. The lateral needles with thread/suture are extended by turning the top control screw. By means of strong tension on the peritoneum and fascia. The thread inserted in this way is taken up and tied by hand. Thus you determine the thread tension on the tissue in the usual manner.



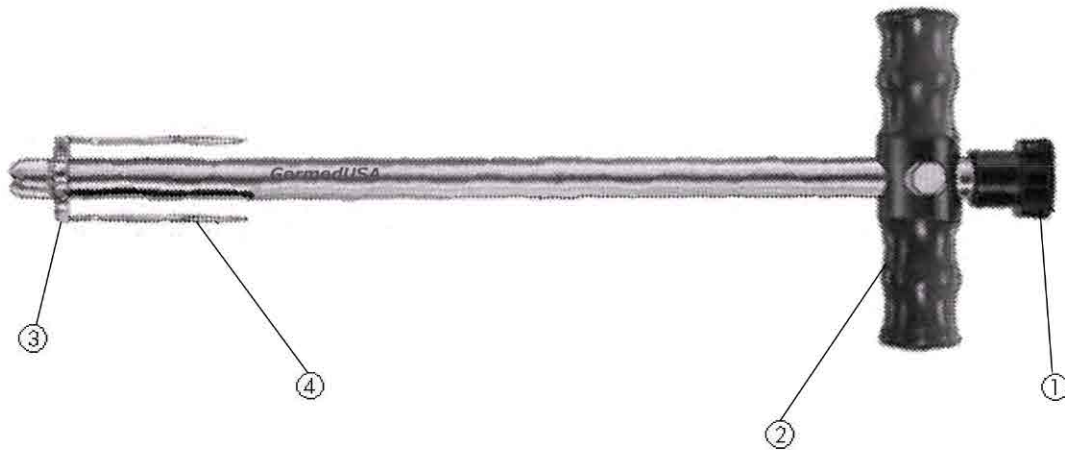

Key: Deep Suture	
①	Control screw
②	Handle
③	Lateral needle holder
④	Special needle

Technical alteration reserved.

79-00001	Deep Suture suitable for 3cm and 5cm needles	\$1,600.00
1 Box = 12 pair needles		
Exclusive swedged-on double armed needles + suture		
79-00004	3 cm needle, 60 cm suture, Polypropylene	Call for code
79-00005	5 cm needle, 60 cm suture, Polypropylene	Call for code
79-00006	3 cm needle, 60 cm suture, Chromic gut	Call for code
79-00007	5 cm needle, 60 cm suture, Chromic gut	Call for code
79-00008	12 Spare eye type needles 3 cm, for Deep Suture	Call for code
79-00009	4 Spare eye type needles 5 cm, for Deep Suture	\$100.00
79-00010	Special oil P-102 100 ml, for all instruments	\$60.00
79-00015	Needle holder with tungsten carbide	Call for code

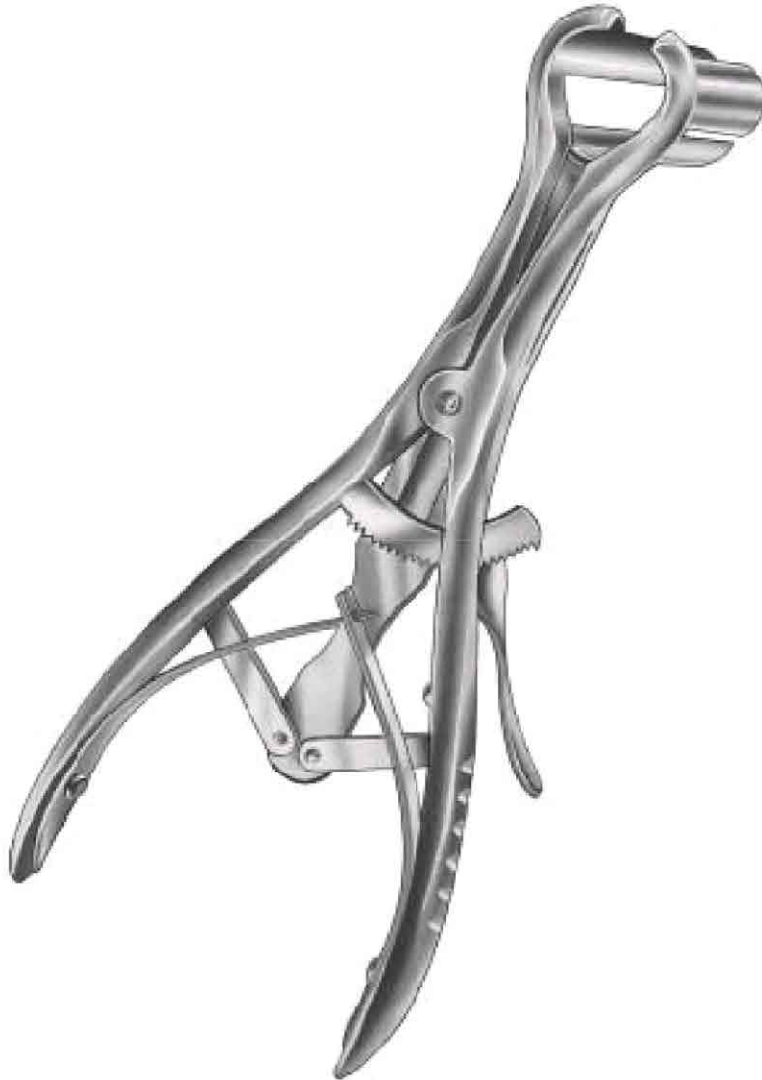

73-00037

\$1,630.00

Speculum for Gallbladder extraction

Trocar Sleeves with Trumpet Valve and Stopcock

77-00505	5 mm	\$205.00	77-00509	10.5 mm	\$470.00
77-00506	5.5 mm	\$205.00	77-00511	11 mm	\$470.00
77-00510	10 mm	\$235.00	77-00512	12.5 mm	\$470.00



Reducer PPSU

77-00568	10 mm — 5.5 mm	\$100.00
77-00569	11 mm — 5 mm	\$100.00
77-00570	12.5 mm — 10 mm	\$100.00
77-00571	12.5 mm — 5.5 mm	\$100.00



Trocars with Three-edged Tip, suitable for metal (and plastic) Trocar Sleeves

77-01505	5 mm	\$50.00	77-01509	10.5 mm	\$100.00
77-01506	5.5 mm	\$50.00	77-01511	11 mm	\$100.00
77-01510	10 mm	\$50.00	77-01513	12.5 mm	\$100.00



Trocars with Conical Tip

77-02505	5 mm	\$50.00	77-02509	10.5 mm	\$100.00
77-02506	5.5 mm	\$50.00	77-02511	11 mm	\$100.00
77-02510	10 mm	\$50.00	77-02513	12.5 mm	\$100.00



Reuseable Safety Trocar (3-edged grinding)

77-01025	5 mm	\$350.00	77-01031	11 mm	\$700.00
77-01026	5.5 mm	\$350.00	77-01032	12.5 mm	\$700.00
77-01030	10 mm	\$350.00			



Trocar Sleeves with Trumpet Valve

77-00515	15 mm	\$300.00
77-00520	20 mm	\$300.00



Trocars with Three-edged Tip

77-01515	15 mm	\$55.00
77-01520	20 mm	\$55.00



Trocars with Conical Tip

77-02515	15 mm	\$50.00
77-02520	20 mm	\$50.00



Spare Parts for Trocar Sleeve

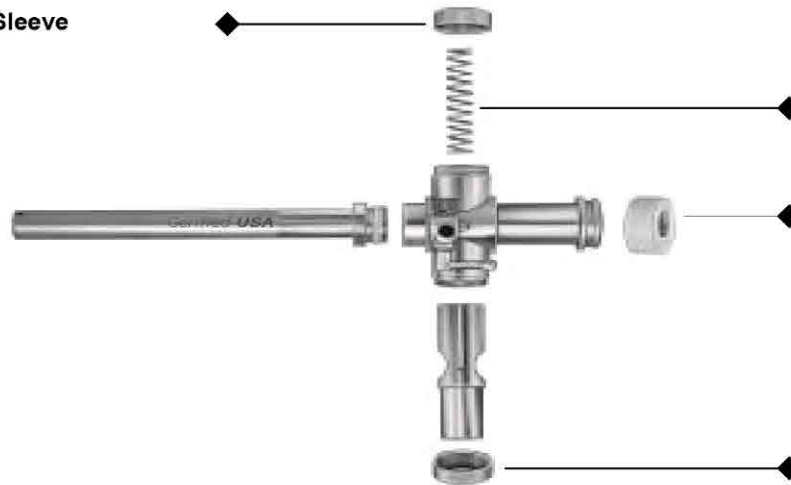

Trocar sizes	Valve cap, closed		Spring		Sealing cap, 10 pieces		Valve cap, open	
5 mm	77-00600	\$30.00	77-00610	\$10.00	77-00620	\$60.00	77-00630	\$30.00
5.5 mm	77-00601	\$30.00	77-00611	\$10.00	77-00621	\$60.00	77-00631	\$30.00
10 mm	77-00602	\$30.00	77-00612	\$10.00	77-00622	\$60.00	77-00632	\$30.00
10.5 mm	77-00603	\$40.00	77-00613	\$10.00	77-00623	\$60.00	77-00633	\$30.00
11 mm	77-00604	\$40.00	77-00614	\$16.00	77-00624	\$60.00	77-00634	\$30.00
12.5 mm	77-00605	\$30.00	77-00615	\$16.00	77-00625	\$60.00	77-00635	\$30.00
15 mm	77-00606	\$40.00	77-00616	\$16.00	77-00626	\$70.00	77-00636	\$25.00
20 mm	77-00607	\$40.00	77-00617	\$16.00	77-00627	\$70.00	77-00637	\$25.00

Trocar Sleeves with Stopcock and Folding Valve

77-00535	5 mm	\$470.00
77-00536	5.5 mm	\$470.00
77-00540	10 mm	\$490.00
77-00541	11 mm	\$500.00
77-00542	12.5 mm	\$500.00



Automatic Trocar Sleeve with Manual Trap Door

77-00735	5 mm	\$500.00
77-00736	5.5 mm	\$500.00
77-00740	10 mm	\$570.00
77-00741	11 mm	\$570.00
77-00742	12.5 mm	\$600.00



Spare Parts for Trocar Sleeves



Trocar sizes	◆ Sealing ring, 10 pieces		◆ Sealing ring, 10 pieces		◆ Screw cap		◆ Sealing cap, 10 pieces	
5 mm	77-00700	\$120.00	77-00710	\$120.00	77-00720	\$40.00	77-00730	\$60.00
5.5 mm	77-00701	\$120.00	77-00711	\$120.00	77-00721	\$40.00	77-00731	\$60.00
10 mm	77-00702	\$120.00	77-00712	\$120.00	77-00722	\$40.00	77-00732	\$60.00
10.5 mm	77-00703	\$80.00	77-00713	\$80.00	77-00723	\$50.00	77-00733	\$60.00
11 mm	77-00704	\$80.00	77-00714	\$80.00	77-00724	\$50.00	77-00734	\$60.00
12.5 mm	77-00705	\$80.00	77-00715	\$80.00	77-00725	\$60.00	77-00735	\$70.00



Reducer Sleeve

77-00113	15 mm —10 mm	\$90.00
77-00114	15 mm —11 mm	\$90.00
77-00116	20 mm — 5 mm	\$100.00
77-00118	20 mm —10 mm	\$100.00
77-00120	20 mm —11 mm	\$100.00



Trocar-Stop

77-00090	5 mm	\$100.00	77-00093	10.5 mm	\$120.00
77-00091	6.5 mm	\$100.00	77-00094	11 mm	\$120.00
77-00092	10 mm	\$120.00	77-00095	12.5 mm	\$120.00



Dilation Sets, consisting of dilation rod and dilation sleeve

77-00132	5 mm —10 mm	\$210.00	77-00146	10 mm —20 mm	\$210.00
77-00140	5 mm —15 mm	\$210.00	77-00148	11 mm —15 mm	\$220.00
77-00142	5 mm — 20 mm	\$210.00	77-00150	11 mm —20 mm	\$220.00
77-00144	10 mm —15 mm	\$210.00			



Insufflation Needle

77-00160	2.00 x 100 mm	\$100.00
77-00162	2.00 x 120 mm	\$100.00
77-00164	2.00 x 140 mm	\$110.00
77-00165	2.00 x 150 mm	\$100.00
77-00170	2.00 x 200 mm	\$110.00



Palpation probe graduated

77-03510	330 mm	5 mm	\$80.00
77-03511	450 mm	5mm	\$90.00

All telescopes are equipped with a 3-way variable cable connector to connect the following systems:

ACM, BRITISH, WOLF, HSW, STORTZ, OLYMPUS



**Optics for Laparoscopy
Autoclavable at 2, 3 bar (134°C)**

71-00010	5 mm	direct vision	0°	\$5,030.00
71-00020	5 mm	foroblique	30°	\$5,180.00
71-00030	10 mm	direct vision	0°	\$4,750.00
71-00040	10 mm	foroblique	30°	\$4,890.00
71-00050	10mm	direct vision	45°	\$5,800.00



**Sterilizable Optic Heater protects the optics
outside of the OP-field of loss of heat**

71-00100	for 5 mm Optics	\$90.00
71-00110	for 10 mm Optics	\$90.00



Fiber Light Cables, Autoclavable at 2 bar (134°C)

Endoskop-Adapter		180 length		230 length		300 length	
Rema / Storz	4.8	71-00200	\$500.00	71-00210	\$440.00	71-00220	\$700.00
	6.0	71-00201	\$950.00	71-00211	\$1,150.00	71-00221	\$1,310.00
Winter / Ibe	4.8	71-00202	\$560.00	71-00212	\$660.00	71-00222	\$790.00
	6.0	71-00203	\$950.00	71-00213	\$1,170.00	71-00223	\$1,320.00
Wolf / HSW	4.8	71-00204	\$570.00	71-00214	\$690.00	71-00224	\$800.00
	6.0	71-00205	\$960.00	71-00215	\$1,150.00	71-00225	\$1,330.00
ACM / British	4.8	71-00206	\$550.00	71-00216	\$690.00	71-00226	\$800.00
	6.0	71-00207	\$960.00	71-00217	\$1,150.00	71-00227	\$1,330.00

angle connection for projector side

71-00300	\$90.00
----------	---------

Type A



HF Connection Cables

72-00000	Type A	3.50 m Length	\$100.00
72-00600	Type B	3.50 m Length	\$100.00

Type B



Hook-tip electrodes insulated up to the front,
To the maximum extent

Type A



Type B



Blunt	Type A		Type B	
Length 330 mm	72-00001	\$250.00	72-00501	\$250.00
Length 450 mm	72-00101	\$260.00	72-00601	\$260.00



Diamond Shaped Cutting Surface	Type A		Type B	
Length 330 mm	72-00002	\$250.00	72-00502	\$250.00
Length 450 mm	72-00102	\$260.00	72-00602	\$260.00



Blunt	Type A		Type B	
Length 330 mm	72-00003	\$250.00	72-00503	\$250.00
Length 450 mm	72-00103	\$260.00	72-00603	\$260.00



Diamond Shaped Cutting Surface	Type A		Type B	
Length 330 mm	72-00004	\$250.00	72-00504	\$250.00
Length 450 mm	72-00104	\$260.00	72-00604	\$260.00



Diamond Shaped Cutting Surface	Type A		Type B	
Length 330 mm	72-00005	\$250.00	72-00505	\$250.00
Length 450 mm	72-00105	\$260.00	72-00605	\$260.00

Hook-tip electrodes insulated up to the front,
To the maximum extent, as well as on the back up to the tip

Type A



Type B



Blunt Curved	Type A		Type B	
Length 330 mm	72-00011	\$280.00	72-00511	\$280.00
Length 450 mm	72-00111	\$290.00	72-00611	\$290.00



Diamond Shaped Cutting Surface	Type A		Type B	
Length 330 mm	72-00012	\$300.00	72-00512	\$300.00
Length 450 mm	72-00112	\$310.00	72-00612	\$310.00



Blunt	Type A		Type B	
Length 330 mm	72-00013	\$290.00	72-00513	\$290.00
Length 450 mm	72-00113	\$300.00	72-00613	\$300.00



Diamond Shaped Cutting Surface	Type A		Type B	
Length 330 mm	72-00014	\$300.00	72-00514	\$300.00
Length 450 mm	72-00114	\$310.00	72-00614	\$310.00



Diamond Shaped Cutting Surface	Type A		Type B	
Length 330 mm	72-00015	\$300.00	72-00515	\$300.00
Length 450 mm	72-00115	\$310.00	72-00615	\$310.00

Type A



Type B



Button Tip Electrode	Type A		Type B	
Length 300 mm	72-00020	\$170.00	72-00520	\$240.00
Length 450 mm	72-00120	\$240.00	72-00620	\$150.00



Cone Tip Electrode	Type A		Type B	
Length 300 mm	72-00021	\$170.00	72-00521	\$240.00
Length 450 mm	72-00121	\$260.00	72-00621	\$150.00



Knife Tip Electrode	Type A		Type B	
Length 300 mm	72-00022	\$180.00	72-00522	\$260.00
Length 450 mm	72-00122	\$150.00	72-00622	\$290.00



Loop Tip Electrode	Type A		Type B	
Length 300 mm	72-00023	\$170.00	72-00523	\$240.00
Length 450 mm	72-00123	\$260.00	72-00623	\$150.00



Coagulation and suction-cannula, insulated, with trumpet valve

73-00001	\$280.00
----------	----------



Dissecting Spatula, insulated, with trumpet valve and suction

73-00002	\$280.00
----------	----------



Dissecting Hook, insulated, with trumpet valve and suction

73-00003	\$280.00
----------	----------



Dissecting Hook, right-angled, insulated, with trumpet valve and suction

73-00004	\$300.00
----------	----------



Coagulation and suction-cannula, insulated

73-00011	\$160.00
----------	----------



Dissecting Spatula, insulated, with suction

73-00012	\$160.00
----------	----------



Dissecting Hook, insulated, with suction

73-00013	\$160.00
----------	----------



Dissecting Hook, right-angled, insulated, with suction

73-00014	\$160.00
----------	----------

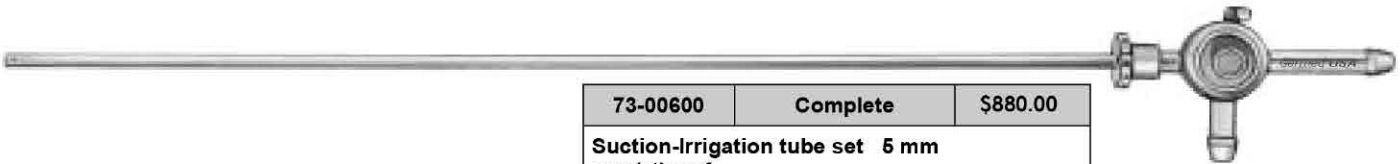

73-00600	Complete	\$880.00
Suction-Irrigation tube set 5 mm consisting of:		
7 Suction-Irrigation tubes Fig. 1 to 7		
1 Sliding Valve		
73-00601	Sliding valve only	\$360.00



73-00602	Complete	\$880.00
Suction-Irrigation tube set 5 mm consisting of:		
7 Suction-Irrigation tubes Fig. 1 to 7		
1 Trumpet Valve		
73-00603	Trumpet valve only	\$380.00



Suction-Irrigation tube	
73-00610	\$70.00



Suction-Irrigation tube	
73-00611	\$70.00



Suction-Irrigation tube	
73-00612	\$70.00



73-00613	\$80.00	see above, but 500mm
-----------------	----------------	-------------------------



Suction-Irrigation tube	
73-00614	\$70.00



Suction-Irrigation tube	
73-00615	\$90.00



Suction-Irrigation tube	
73-00616	\$90.00



73-00620	Complete	\$690.00
Suction-Irrigation tube set 5 mm		
73-00621	Suction-Irrigation tube 5 mm	\$70.00
73-00622	Suction-Irrigation tube 10 mm	\$70.00
73-00623	Trumpet valve	\$620.00





73-00008	\$320.00
----------	----------

Suction and Irrigation tube, with central tube laser fiber



73-00005	\$360.00
----------	----------

Suction and Irrigation tube, with central tube laser fiber



73-00006	\$140.00
----------	----------

Suction tube with stop cock, Luer Lock



73-00007	\$290.00
----------	----------

Suction and Irrigation tube with two trumpet valves



73-00015	6 mm	\$20.00
73-00016	8 mm	\$20.00
connector, Luer Lock		
(female)		



73-00017	6 mm	\$20.00
73-00018	8 mm	\$20.00
connector, Luer Lock		
(male)		



73-00039	\$1,050.00
----------	------------

Cholangiographie Fixation forceps



73-00041	\$80.00
----------	---------

Injection and puncture needle, LuerLock



73-00042	\$200.00
----------	----------

Two-way stopcock for contrast medium



73-00043	\$80.00
----------	---------

Guide tube for Cholangi catheter



73-00044	\$70.00
----------	---------

Guide hook for Cholangi catheter

GermedUSA Inc.

INSTRUMENT LINE - easy change

The following benefits offers the newest *GermedUSA* Laparoscopy instrument line "easy change".

- Ergonomic light design, excellent cleaning quality e.g. fast, effective and simple. Every instrument features additionally extra fast cleaning possibility via "Luer Lock".
- Very easy and simple handling as handle can be removed by pressing with one finger, this corresponds to a quick lock as no screws are used any longer.
- For handles with ratchet we developed a new comfortable ratchet design with easy handling. The users finger posture is the same like holding a handle without ratchet.

The handicap through the traditional ratchet on the handle is cancelled.

"Easy change line" is in 5mm and in 10mm available. **NEW!!** For 5mm inserts as well as for the 10mm you use the same handle. All instruments are 360 rotatable and auto-clavable. Can be taken apart fast and easily into 3 parts: handle, outer tube and working insert.



5 mm	Working Length	Handle 75-000-101	Handle 75-000-103	Handle 75-000-105	Handle 75-000-107	Handle 75-000-147
	330 mm					
430 mm						
	Hook scissors, straight					
	75-051-000	\$370.00	75-051-101	\$770.00		
	76-051-000	\$370.00	76-051-101	\$770.00		
	Peritoneal scissors, straight					
	75-082-000	\$370.00	75-082-101	\$770.00		
	76-082-000	\$370.00	76-082-101	\$770.00		
	Micro dissecting scissors, straight					
	75-048-000	\$370.00	75-048-101	\$770.00	75-048-105	\$770.00
	Micro dissecting scissors, curved left					
	75-049-000	\$370.00	75-049-101	\$770.00	75-049-105	\$770.00
	METZENBAUM, Dissecting scissors, short, curved					
	75-047-000	\$370.00	75-047-101	\$770.00		
	METZENBAUM, Dissecting scissors, straight					
	75-054-000	\$370.00	75-054-101	\$770.00		
	76-054-000	\$370.00	76-054-101	\$770.00		
	METZENBAUM, Dissecting scissors, curved					
	75-056-000	\$370.00	75-056-101	\$770.00		
	76-056-000	\$370.00	76-056-101	\$770.00		
	Biopsy forceps					
	75-063-000	\$370.00	75-063-101	\$770.00		
	76-063-000	\$370.00	76-063-101	\$770.00		
	Biopsy forceps with thorn					
	75-064-000	\$370.00	75-064-101	\$770.00		
	76-064-000	\$370.00	76-064-101	\$770.00		















Outer Tube 330 mm 75-000-100 5mm
430 mm 76-000-100 5mm



5 mm	Working Length	Handle 75-000-101	Handle 75-000-103	Handle 75-000-105	Handle 75-000-107	Handle 75-000-147
	330 mm					
	430 mm					
	BLAKESLY, Biopsy forceps					
	75-081-000		75-081-101			
	76-081-000		76-081-101			
	Biopsy punch					
	75-060-000		75-060-101			
	76-060-000		76-060-101			
	Biopsy punch					
	75-062-000		75-062-101			
	76-062-000		76-062-101			
	Grasping forceps					
	75-065-000		75-065-101		75-065-103	
	76-065-000		76-065-101		76-065-103	
	Grasping forceps Fenestrated					
	75-079-000		75-079-103			
	76-079-000		76-079-103			
	Grasping forceps, delicate pattern					
	75-066-000		75-066-103			
	76-066-000		76-066-103			
	Grasping forceps, heavy pattern					
	75-078-000		75-078-103			
	76-078-000		76-078-103			
	Grasping forceps					
	75-068-000		75-068-103			
	76-068-000		76-068-103			
	Grasping forceps, pointed					
	75-069-000		75-069-103			
	76-069-000		76-069-103			

Outer Tube 330 mm 75-000-100 5mm
 430 mm 76-000-100 5mm



5 mm	Working Length	Handle 75-000-101	Handle 75-000-103	Handle 75-000-105	Handle 75-000-107	Handle 75-000-147
	330 mm					
	430 mm					
	Grasping forceps					
	75-075-000	\$380.00	75-075-103	\$800.00		
	76-075-000	\$380.00	76-075-103	\$800.00		
	Dissecting forceps, atraumatic serration					
	75-070-000	\$380.00	75-070-101	\$800.00	75-070-103	\$820.00
	76-070-000	\$380.00	76-070-101	\$800.00	76-070-103	\$820.00
	MARYLAND, Dissecting forceps, curved					
	75-072-000	\$380.00	75-072-101	\$800.00		
	76-072-000	\$380.00	76-072-101	\$800.00		
	Dissecting forceps, curved 45					
	75-246-000		75-246-101		75-246-105	
	76-246-000		76-246-101		76-246-105	
	Dissecting forceps, curved 90					
	75-247-000		75-247-101		75-247-105	
	Grasping forceps, atraumatic, De Bakey					
	75-242-000		75-242-103		75-242-107	
	76-242-000		76-242-103		76-242-107	
	Grasping forceps					
	75-077-000		75-077-103			
	76-077-000		76-077-103			
	Grasping forceps 2x3 teeth					
	75-076-000		75-076-103			
	76-076-000		76-076-103			
	Claw forceps 2x3 teeth					
	75-083-000		75-083-103		75-083-107	













Outer Tube 330 mm 75-000-100 5mm
 430 mm 76-000-100 5mm



5 mm	Working Length	Handle 75-000-101	Handle 75-000-103	Handle 75-000-105	Handle 75-000-107	Handle 75-000-147
	330 mm					
	430 mm					
	Grasping forceps HI with tungsten carbide					
	75-286-000		75-286-103		75-286-107	
	76-286-000		76-286-103		76-286-107	
	ALLIS, Grasping forceps					
	75-105-000		75-105-103		75-105-107	
	ALLIS, Grasping forceps, atraumatic, De Bakey					
	75-111-000		75-111-103		75-111-107	
	Endo-Forceps with single De Bakey, closing protection					
	75-198-000		75-198-103		75-198-107	
	KOCHER, Grasping forceps, atraumatic, De Bakey					
	75-171-000		75-171-103		75-171-107	
	Endo-Lung Palpation forceps					
	75-233-000		75-233-101		75-233-105	
	Dissecting forceps 90 curved, using with 12,5 mm trocar sleeve					
	75-067-000		75-067-101		75-067-105	
	Needle holder with tungsten carbide inserts 8 mm					
	75-201-000		75-201-107		75-201-147	
	Suture fixation forceps, U-shaped jaws					
	75-248-000		75-248-107		75-248-147	







Outer Tube 330 mm 75-000-100 5mm
 430 mm 76-000-100 5mm



10 mm	Working Length	Handle 75-000-201	Handle 75-000-203	Handle 75-000-205	Handle 75-000-207	
	330 mm					
	Operating scissors, large					
	75-084-000		75-084-201		75-084-205	
	Spoon forceps, large					
	75-180-000		75-180-201		75-180-207	
	Claw forceps 2x3 teeth					
	75-179-000		75-179-203		75-179-207	
	Grasping forceps, heavy pattern					
	75-225-000		75-225-203		75-225-207	
	MARYLAND, Dissecting forceps, curved					
	75-074-000		75-074-201		75-074-203	
	ALLIS, Grasping forceps					
	75-101-000		75-101-203		75-101-207	
	ALLIS, Grasping forceps, atraumatic, De Bakey					
	75-108-000		75-108-203		75-108-207	
	BABCOCK, Grasping forceps					
	75-120-000		75-120-203		75-120-207	
	BABCOCK, Grasping forceps, atraumatic, De Bakey					
	75-123-000		75-123-203		75-123-207	











Outer Tube 330 mm 75-000-200 10mm



10 mm	Working Length	Handle 75-000-201	Handle 75-000-203	Handle 75-000-205	Handle 75-000-207	
	330 mm					
	DUVAL, Grasping forceps					
	75-176-000		75-176-203		75-176-207	
	COLLIN, Grasping forceps, atraumatic					
	75-181-000		75-181-203		75-181-207	
	Dissecting-Grasping forceps, atraumatic, DeBakey					
	75-080-000		75-080-201		75-080-203	

Outer Tube **330 mm 75-000-200 10mm**



10 mm	Jaw Length	Working Length	Handle 75-000-201	Handle 75-000-203	Handle 75-000-205	Handle 75-000-207
	Diameter	330 mm				
	KOCHER, Grasping forceps, atraumatic					
	50MM / 10MM	75-132-000		75-132-203		75-132-207
	60MM / 10MM	75-135-000		75-135-203		75-135-207
	KOCHER, Grasping forceps, atraumatic, single DeBakey					
	50MM / 10MM	75-147-000		75-147-203		75-147-207
	60MM / 10MM	75-150-000		75-150-203		75-150-207
	KOCHER, Grasping forceps, atraumatic, double DeBakey					
	50MM / 10MM	75-162-000		75-162-203		75-162-207
	60MM / 10MM	75-165-000		75-165-203		75-165-207
	Endo-Forceps with single DeBakey, closing protection					
	50MM / 10MM	75-196-000		75-196-203		75-196-207
	60MM / 10MM	75-197-000		75-197-203		75-196-207
	Endo-Forceps with double DeBakey, closing protection					
	50MM / 10MM	75-192-000		75-192-203		75-192-207
	60MM / 10MM	75-193-000		75-193-203		75-192-207
	Endo-Lung Palpation forceps					
	50MM / 10MM	75-231-000		75-231-203		75-231-207
	60MM / 10MM	75-232-000		75-232-203		75-231-207

Outer Tube 330 mm 75-000-200 10mm



With the detachable instruments *Germed USA* introduces the latest generation of laparoscopic instruments, which can be easily disassembled for a thorough, so far not possible, cleaning. Through the unique constructional conception, it is also possible, that the interchangeable basic elements of each instrument can be combined with various handles.

In case of erosion of the instruments' insert, it can be replaced by a new one. This leads to a clear lowering of costs, as only the instruments insert has to be exchanged and not the complete instrument.

The detachable *Germed USA* instruments offer therefore best possible protection against infection, and they are user-friendly through an easy disassembly and the combination of the instrument inserts with various handles. As the basic elements like handle and instrument insert can be ordered separately they are cost lowering. These instruments offer a clearly improved cost-use relation.

ASSEMBLED INSTRUMENT

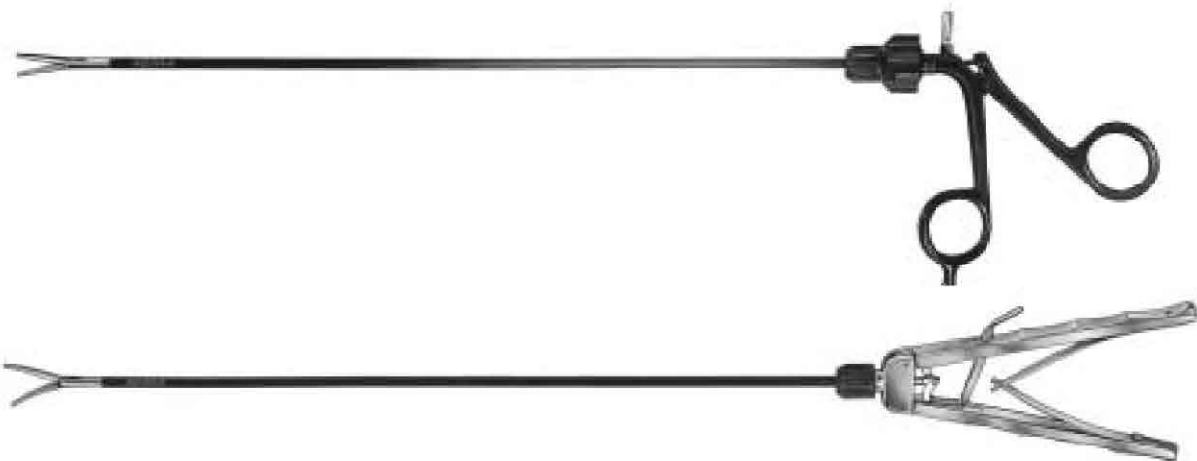

DISASSEMBLED INSTRUMENT



Insert, with instrument tip



Outer tube with screw cap



Handle

5 mm	Working Length	Handle 72-000-101	Handle 72-000-103	Handle 72-000-105	Handle 72-000-107	Handle 72-000-147
	330 mm					
	430 mm					
	Hook scissors, straight					
	72-051-000		72-051-101			
	74-051-000		72-051-101			
	Hook scissors, curved left					
	72-053-000		72-053-101			
	Peritoneal scissors, straight					
	72-082-000		72-082-101			
	74-082-000		74-082-101			
	Micro dissecting scissors, straight					
	72-048-000		72-048-101		72-048-105	
	Micro dissecting scissors, curved left					
	72-049-000		72-049-101		72-049-105	
	METZENBAUM, Dissecting scissors, straight					
	72-046-000		72-046-101			
	METZENBAUM, Dissecting scissors, curved					
	72-047-000		72-047-101			
	METZENBAUM, Dissecting scissors, straight					
	72-054-000		72-054-101			
	74-054-000		74-054-101			
	METZENBAUM, Dissecting scissors, curved					
	72-056-000		72-056-101			
	74-056-000		74-056-101			

Outer Tube 330 mm 72-000-100 5mm
 430 mm 74-000-100 5mm



5 mm	Working Length	Handle 72-000-101	Handle 72-000-103	Handle 72-000-105	Handle 72-000-107	Handle 72-000-147
	330 mm					
	430 mm					
	METZENBAUM, Dissecting scissors, straight, with teeth					
	72-057-000		72-057-101			
	74-057-000		74-057-101			
	METZENBAUM, Dissecting scissors, curved, with teeth					
	72-059-000		72-059-101			
	74-059-000		74-059-101			
	Biopsy forceps					
	72-063-000		72-063-101			
	74-063-000		74-063-101			
	Biopsy forceps with thorn					
	72-064-000		72-064-101			
	74-064-000		74-064-101			
	BLAKESLY, Biopsy forceps					
	72-081-000		72-081-101			
	74-081-000		74-081-101			
	Biopsy punch					
	72-060-000		72-060-101			
	74-060-000		74-060-101			
	Biopsy punch					
	72-062-000		72-062-101			
	74-062-000		74-062-101			
	Grasping forceps					
	72-065-000		72-065-103			
	74-065-000		72-065-103			
	Grasping forceps, fenestrated					
	72-079-000		72-079-103			
	74-079-000		74-079-103			

Outer Tube 330 mm 72-000-100 5mm
 430 mm 74-000-100 5mm



5 mm	Working Length	Handle 72-000-101	Handle 72-000-103	Handle 72-000-105	Handle 72-000-107	Handle 72-000-147
		330 mm				
	430 mm					
	Grasping forceps, delicate pattern					
	72-066-000		72-066-103			
	74-066-000		74-066-103			
	Grasping forceps, heavy pattern					
	72-078-000		72-078-103			
	74-078-000		74-078-103			
	Grasping forceps					
	72-068-000		72-068-103			
	74-068-000		74-068-103			
	Grasping forceps, pointed					
	72-069-000		72-069-103			
	74-069-000		74-069-103			
	Grasping forceps					
	72-075-000		72-075-103			
	74-075-000		74-075-103			
	Dissecting forceps, atraumatic serration					
	72-070-000		72-070-101			
	74-070-000		74-070-101			
	MARYLAND, Dissecting forceps, curved					
	72-072-000		72-072-101			
	74-072-000		74-072-101			
	Dissecting forceps, curved 45					
	72-246-000		72-246-101		72-246-105	
	74-246-000		74-246-101		74-246-105	
	Dissecting forceps, curved 90					
	72-247-000		72-247-101		72-247-105	

Outer Tube 330 mm 72-000-100 5mm
430 mm 74-000-100 5mm



5 mm	Working Length	Handle 72-000-101	Handle 72-000-103	Handle 72-000-105	Handle 72-000-107	Handle 72-000-147
	330 mm					
	430 mm					
	Grasping forceps, atraumatic, De Bakey, with tungsten carbide					
	72-240-000		72-240-103		72-240-107	
	Grasping forceps, atraumatic, De Bakey					
	72-242-000		72-242-103		72-242-107	
	74-242-000		74-242-103		74-242-107	
	Grasping forceps					
	72-077-000		72-077-103			
	74-077-000		74-077-103			
	Grasping forceps 2x3 teeth					
	72-076-000		72-076-103			
	74-076-000		74-076-103			
	Claw forceps 2x3 teeth					
	72-083-000		72-083-103		72-083-107	
	DORSEY, Grasping forceps					
	72-249-000		72-249-103		72-249-107	
	Grasping forceps HI with tungsten carbide					
	72-286-000		72-286-103		72-286-107	
	74-286-000		74-286-103		74-286-107	
	ALLIS, Grasping forceps					
	72-105-000		72-105-103		72-105-107	
	ALLIS, grasping forceps, atraumatic, De Bakey					
	72-111-000		72-111-103		72-111-107	













Outer Tube 330 mm 72-000-100 5mm
 430 mm 74-000-100 5mm



5 mm	Working Length	Handle 72-000-101	Handle 72-000-103	Handle 72-000-105	Handle 72-000-107	Handle 72-000-147
	330 mm					
430 mm						
	ALLIS, Grasping forceps, atraumatic, with tungsten carbide					
	72-117-000		72-117-103		72-117-107	
	KOCHER, Grasping forceps, atraumatic, De Bakey					
	72-171-000		72-171-103		72-171-107	
	Dissecting forceps, curved					
	72-073-000		72-073-101			
	Dissecting forceps 90 curved, using with 12,5 mm trocar sleeve					
	72-067-000		72-067-101			
	Endo-Forceps with single De Bakey, closing protection					
	72-198-000		72-198-103		72-198-107	
	Endo-Lung Palpation forceps					
	72-233-000		72-233-101		72-233-105	
	Needle holder with tungsten carbide inserts 8 mm					
	72-201-000				72-201-147	
	Needle holder with tungsten carbide inserts 10 mm					
	72-203-000				72-203-147	
	Suture fixation forceps, U-shaped jaws					
	72-248-000				72-248-147	

Outer Tube 330 mm 72-000-100 5mm



10 mm	Working Length	Handle 72-000-202	Handle 72-000-204	Handle 72-000-206	Handle 72-000-208	
	330 mm					
	Operating scissors, large					
	72-084-000	\$380.00	72-084-202	call for code	72-084-206	\$740.00
	Spoon forceps, large					
	72-180-000	\$380.00	72-180-204	call for code	72-180-208	\$820.00
	Claw forceps 2x3 teeth					
	72-179-000	\$380.00	72-179-204	call for code	72-179-208	\$820.00
	Grasping forceps, heavy pattern					
	72-225-000	\$380.00	72-225-204	Call for code	72-225-208	\$820.00
	MARYLAND, Dissecting forceps, curved					
	72-074-000	\$380.00	72-074-202	\$720.00		
	ALLIS, Grasping forceps					
	72-101-000	\$420.00	72-101-204	call for code	72-101-208	\$860.00
	ALLIS, Grasping forceps, atraumatic, De Bakey					
	72-108-000	\$420.00	72-108-204	call for code	72-108-208	\$860.00
	ALLIS, Grasping forceps, atraumatic, with tungsten carbide					
	72-214-000	\$420.00	72-214-204	call for code	72-214-208	\$860.00
	BABCOCK, Grasping forceps					
	72-120-000	\$420.00	72-120-204	call for code	72-120-208	\$860.00











Outer Tube 330 mm 72-000-200 10mm



10 mm	Working Length	Handle 72-000-202	Handle 72-000-204	Handle 72-000-206	Handle 72-000-208	
	330 mm					
	BABCOCK, Grasping forceps, atraumatic, De Bakey					
	72-123-000	\$420.00	72-123-204	call for code	72-123-208	\$860.00
	BABCOCK, Grasping forceps, atraumatic, with tungsten carbide					
	72-220-000	\$420.00	72-220-204	call for code	72-220-208	\$860.00
	DUVAL, Grasping forceps					
	72-176-000	\$420.00	72-176-204	call for code	72-176-208	\$860.00
	COLLIN, Grasping forceps, atraumatic					
	72-181-000	\$420.00	72-181-204	call for code	72-181-208	\$860.00
	COLLIN, Grasping forceps, atraumatic, with tungsten carbide inserts					
	72-074-000	\$380.00	72-074-202	\$710.00		
	Dissecting-Grasping forceps, atraumatic, De Bakey					
	72-080-000	\$380.00	72-080-202	\$740.00		

Outer Tube 330 mm 72-000-200 10mm



10 mm	Jaw Length	Working Length	Handle 72-000-202	Handle 72-000-204	Handle 72-000-206	Handle 72-000-208
	Diameter	330 mm				
	KOCHER, Grasping forceps, atraumatic					
	30MM / 10MM	72-126-000	\$420.00	72-126-204	call for code	72-126-208
	40MM / 10MM	72-129-000	\$420.00	72-129-204	call for code	72-129-208
	50MM / 10MM	72-132-000	\$420.00	72-132-204	call for code	72-132-208
	60MM / 10MM	72-135-000	\$420.00	72-135-204	call for code	72-135-208
	KOCHER, Grasping forceps, atraumatic, single De Bakey					
	30MM / 10MM	72-141-000	\$420.00	72-141-204	call for code	72-141-208
	40MM / 10MM	72-144-000	\$420.00	72-144-204	call for code	72-144-208
	50MM / 10MM	72-147-000	\$420.00	72-147-204	call for code	72-147-208
	60MM / 10MM	72-150-000	\$420.00	72-150-204	call for code	72-150-208
	KOCHER, Grasping forceps, atraumatic, double De Bakey					
	30MM / 10MM	72-156-000	\$420.00	72-156-204	call for code	72-156-208
	40MM / 10MM	72-159-000	\$420.00	72-159-204	call for code	72-159-208
	50MM / 10MM	72-162-000	\$420.00	72-162-204	call for code	72-162-208
	60MM / 10MM	72-165-000	\$420.00	72-165-204	call for code	72-165-208
	Endo-Forceps with single De Bakey, closing protection					
	40MM / 10MM	72-195-000	\$420.00	72-195-204	call for code	72-195-208
	50MM / 10MM	72-196-000	\$420.00	72-196-204	call for code	72-196-208
	60MM / 10MM	72-197-000	\$420.00	72-197-204	call for code	72-197-208
	Endo-Forceps with double De Bakey, closing protection					
	40MM / 10MM	72-191-000	\$420.00	72-191-204	call for code	72-191-208
	50MM / 10MM	72-192-000	\$420.00	72-192-204	call for code	72-192-208
	60MM / 10MM	72-193-000	\$420.00	72-193-204	call for code	72-193-208
	Endo-Lung Palpation forceps					
	40MM / 10MM	72-230-000	\$420.00	72-230-202	call for code	72-230-206
	50MM / 10MM	72-231-000	\$420.00	72-231-202	call for code	72-231-206
	60MM / 10MM	72-232-000	\$420.00	72-232-202	call for code	72-232-206

Outer Tube 330 mm 72-000-200 10mm



The good results of open abdominal surgery can hardly be improved upon using the conventional techniques. Through the application of modern video-endoscopic technology and appropriate instruments, however, the trauma of operative access can be substantially reduced. Small punctures replace abdominal sections. The advantages of minimal invasive surgery are the results.

With a number of new developed instruments *Germed USA Inc.* would like to make an up-to-date contribution to laparoscopic operating techniques.

For neat preparation of the operation situs during laparoscopic operations, *GermedUSA Inc.* now offers you the ideal balanced set of instruments developed in accordance with hundreds of tried and tested examples from classic abdominal surgery.

The new *Germed USA Inc.* Endo Hook System

The Endo Hook System newly developed by *GermedUSA Inc.* is a rod-shaped instrument having a diameter of 5mm and 10mm and on whose front end an Endo hook is fixed. At the top end of the instrument a handle with an operating mechanism is mounted, allowing for infinitely variable adjustment of the respective hook, from 0 to 90 degrees. Thus, with the help of an appropriate *Germed USA Inc.* Endo hook, it is possible to achieve the same beneficial effects as with hooks used in classic abdominal surgery.

ASSEMBLED INSTRUMENT



DISASSEMBLED INSTRUMENT



Insert, with instrument tip



Handle







Outer tube with screw cap

10 mm	Jaw Length	Working Length	Handle 72-000-159	Handle 72-000-260		
	Diameter	330 mm				
	Endo-Retractor Kocher-Langenbeck					
	30MM / 10MM	77-001-000	\$650.00	77-001-159	\$920.00	
	40MM / 10MM	77-002-000	\$650.00	77-002-159	\$920.00	
	50MM / 10MM	77-003-000	\$650.00	77-003-159	\$920.00	
	30MM / 10MM	77-011-000	\$650.00	77-011-260	\$930.00	
	40MM / 10MM	77-012-000	\$650.00	77-012-260	\$930.00	
	50MM / 10MM	77-013-000	\$650.00	77-013-260	\$930.00	
	Endo-Retractor Cushing					
	30MM / 10MM	77-015-000	\$690.00	77-015-260	\$990.00	
	40MM / 10MM	77-016-000	\$690.00	77-016-260	\$990.00	
	50MM / 10MM	77-017-000	\$690.00	77-017-260	\$990.00	
	Endo-Retractor fan-shaped					
	50MM / 5MM	77-021-000	\$600.00	77-021-159	\$900.00	
	60MM / 5MM	77-022-000	\$600.00	77-022-159	\$900.00	
	50MM / 10MM	77-023-000	\$600.00	77-023-260	\$900.00	
	60MM / 10MM	77-024-000	\$600.00	77-024-260	\$900.00	
	Endo-Esophageal-Retractor/Dissector					
	35MM / 5MM	77-030-000	\$680.00	77-030-159	\$930.00	
	35MM / 10MM	77-031-000	\$680.00	77-031-260	\$950.00	
	Endo-Esophageal-Retractor/Dissector					
35MM / 10MM	77-032-000	\$720.00	77-032-260	\$980.00		
	Endo-Laparolifter (in conjunction with CO2 insufflation)					
40MM / 10MM	77-052-000	\$600.00	77-052-260	\$940.00		

Outer Tube 330 mm 72-000-200 10mm
 330 mm 72-000-100 5mm



10 mm	Jaw Length	Working Length	Handle 72-000-260			
	Diameter	330 mm				
	Endo-Eccentric “Y” Retractor					
	40-60MM / 10MM	72-600-000 R	\$720.00	72-600-260 R	\$1,060.00	
	Endo-Eccentric “Y” Retractor					
	60-40MM / 10MM	72-600-000 L	\$720.00	72-600-260 L	\$1,060.00	
	Endo-Eccentric “Y” Retractor					
	60-60MM / 10MM	72-600-000 S	\$720.00	72-600-260 S	\$1,060.00	

Outer Tube **330 mm 72-000-200 10mm**



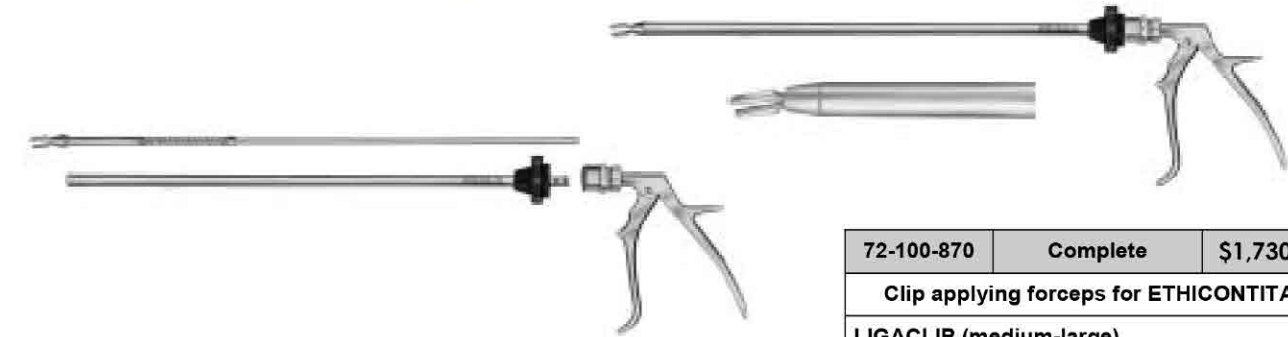

72-100-870	Complete	\$1,730.00
Clip applying forceps for ETHICONTITAN		
LIGACLIP (medium-large)		
consisting of:		
72-100-000	Insert, forceps	\$580.00
72-100-800	Outer tube 10 mm	Call for code
72-100-070	Handle	Call for code
Further forceps Inserts, on request		



78-00500	\$70.00
----------	---------

Applicator for endo-ligature, 5mm



78-00501	\$170.00
----------	----------

Knot-sliding instrument, 5mm



78-00502	\$180.00
----------	----------

Knot guide for extracorporeal knotting, 5mm
(only useable with applicator 78-00500)



78-00503	\$130.00
----------	----------

Knot guide for extracorporeal knotting, 5mm
(only useable with applicator 78-00500)

Endoscope and Instrument Holder	
72-700-000	fully autoclavable
components:	
Germed Articulating post # -3800-40	
(400 mm) fixed with the handle	
Endoscope and Instrument Holder 10 mm	
Thread base on rails 25x10 and 35x8 mm	
Support 300 mm, adjustment of height	





Cleaning Brush, 500 mm length		
79-00011	for Outer tube 5 mm insulated / metal and Outer tube 10 mm insulated	\$16.00
79-00012	for Outer tube 10 mm metal	\$16.00



Instrument Oil P-102		
79-00010	50 ml	\$60.00

**Handles for rotating and detachable
5 mm and 10 mm Instruments:**

**Handles for detachable
5 mm and 10 mm Instruments:**



72-000-101	5 mm	\$110.00
72-000-202	10 mm	Call for code
with HF-connector		
without ratchet		



72-000-121	5 mm	Call for code
72-000-222	10 mm	Call for code
with HF-connector		
without ratchet		



72-000-103	5 mm	\$130.00
72-000-204	10 mm	Call for code
with HF-connector		
with ratchet		

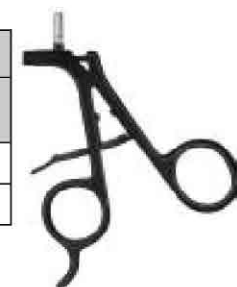

72-000-123	5 mm	Call for code
72-000-224	10 mm	Call for code
with HF-connector		
with ratchet		



72-000-105	5 mm	\$130.00
72-000-206	10 mm	Call for code
without ratchet		



72-000-125	5 mm	Call for code
72-000-226	10 mm	Call for code
without ratchet		



72-000-107	5 mm	\$150.00
72-000-208	10 mm	Call for code
with ratchet		



72-000-127	5 mm	Call for code
72-000-228	10 mm	Call for code
with ratchet		



72-000-109	5 mm	Call for code
72-000-210	10 mm	Call for code
metal spring action		



72-000-129	5 mm	Call for code
72-000-230	10 mm	Call for code
metal spring action		

Handles for rotating and detachable 5 mm and 10 mm Instruments:



72-000-141	5 mm	Call for code
72-000-242	10 mm	Call for code
without ratchet		
72-000-143	5 mm	Call for code
72-000-244	10 mm	Call for code
with ratchet		

Handles for detachable 5 mm and 10 mm Instruments:

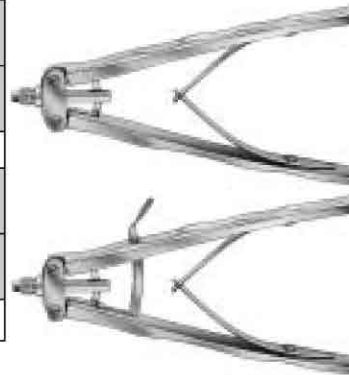

72-000-145	5 mm	Call for code
72-000-246	10 mm	Call for code
without ratchet		
72-000-147	5 mm	Call for code
72-000-248	10 mm	Call for code
with ratchet		
72-000-159	5 mm	Call for code
72-000-260	10 mm	Call for code



Spare Parts



72-000-100	5 mm	Outer tube insulated	\$160.00
72-000-300	5 mm	Outer tube metal	Call for code

Outer tube with screw cap for 5 mm Instruments



72-000-200	10 mm	Outer tube insulated	\$160.00
72-000-400	10 mm	Outer tube metal	Call for code

Outer tube with screw cap for 10 mm Instruments



72-000-500	\$24.00
------------	---------

Screw cap for 5 mm Instruments



72-000-600	\$24.00
------------	---------

Screw cap for 10 mm Instruments

5 mm x 340 mm

ASSEMBLED INSTRUMENT



DISASSEMBLED INSTRUMENT

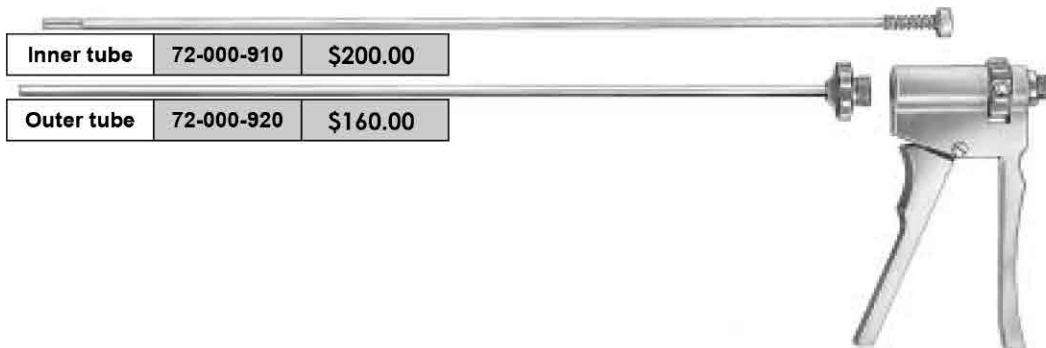

Inner tube	72-000-910	\$200.00
------------	------------	----------

Outer tube	72-000-920	\$160.00
------------	------------	----------

Handle	
72-000-980	\$690.00



72-210-980	Complete	\$1,300.00
Bipolar Forceps 1 mm, complete,		
consisting of:		
72-210-000	Insert forceps	\$300.00
72-000-920	Outer tube 5 mm	\$160.00
72-000-910	Inner tube	\$200.00
72-000-980	Handle	\$690.00

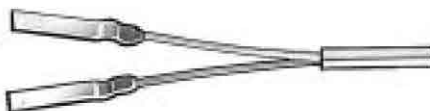

72-211-980	Complete	\$1,300.00
Bipolar Forceps 3 mm, complete,		
consisting of:		
72-211-000	Insert forceps	\$300.00
72-000-920	Outer tube 5 mm	\$160.00
72-000-910	Inner tube	\$200.00
72-000-980	Handle	\$690.00

Detachable Bipolar Coagulation Forceps

5 mm x 340 mm

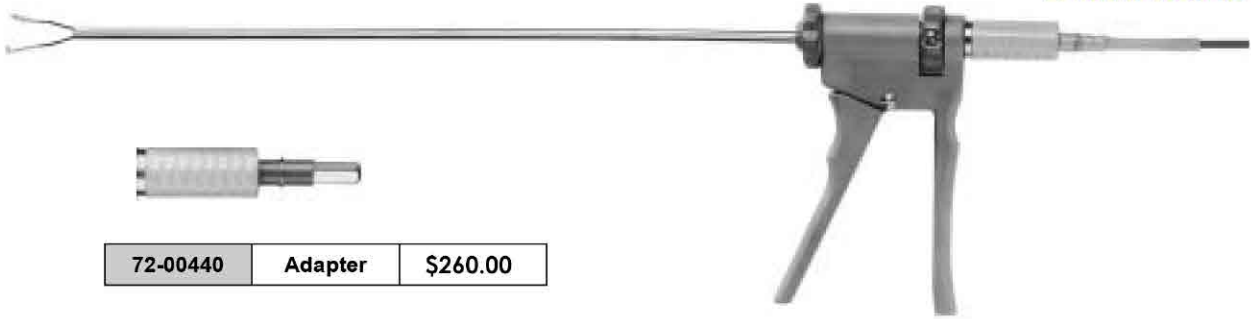

72-00440	Adapter	\$260.00
----------	---------	----------



72-212-980	Complete	\$1,300.00
Bipolar Forceps complete,		
consisting of:		
72-212-000	Insert forceps	\$300.00
72-000-920	Outer tube 5 mm	\$160.00
72-000-910	Inner tube	\$200.00
72-000-980	Handle	\$690.00



72-213-981	Complete	\$1,760.00
Bipolar Scissors complete,		
consisting of:		
72-213-000	Insert forceps	\$660.00
72-000-920	Outer tube 5 mm	\$160.00
72-000-910	Inner tube	\$200.00
72-000-981	Handle	\$760.00



72-00400	\$390.00
Valleylab-Plug	



72-00420	\$260.00
Erbe-Plug	



72-00410	\$300.00
Codman-Plug	



72-00430	\$420.00
Martin/Berchtold-Plug	

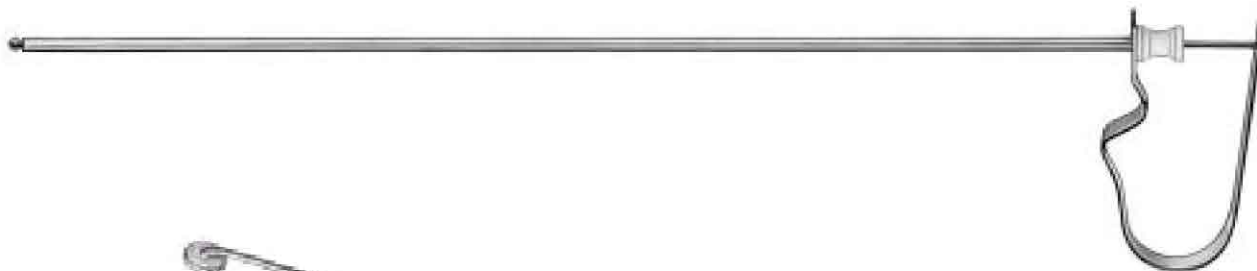

Bowel Forceps

78-00200	\$240.00
----------	----------



Atraumatic Grasping forceps

78-00201	\$240.00
----------	----------



Fimbrial Holding Forceps, t-pattern

78-00202	\$240.00
----------	----------



Fimbrial Holding Forceps, square pattern

78-00203	\$240.00
----------	----------



Fimbrial Holding Forceps, ring pattern

78-00204	\$260.00
----------	----------



Swab Grasper

78-00205	\$300.00
----------	----------